**RUSV42102-KS** [↗](#)

Patin con recirculación a rodillos

Linear roller bearings, with spacer elements,
with integrated adjusting gib, RUSV...-KS

Información técnica

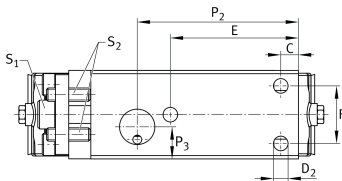
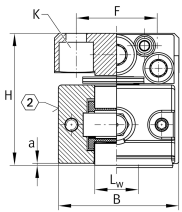

Variante de su producto actual

Size code	42102
Suffix	KS With end face lubrication connectors

Medidas principales y datos de rendimiento

L	114 mm	Longitud total
B	40 mm	Anchura
H	42 mm	Altura
C	95.000 N	Capacidad de carga dinámica
C ₀	151.000 N	Capacidad de carga estática
≈m	1,04 kg	Peso

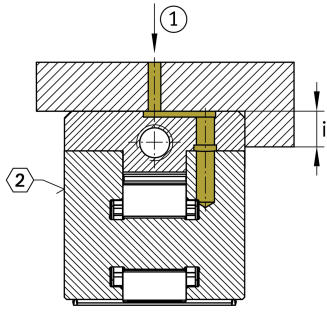
**Medidas de montaje**

L	102 mm	
L ₁	108 mm	
L ₃	68,4 mm	
L ₄	70 mm	
a	0,3 mm	
L _W	14 mm	
C	8 mm	
E	38 mm	Medidas de montaje
F	26 mm	
i	6 mm	Medidas de montaje
P ₁	29,5 mm	
d ₁	16 mm	
P ₂	53 mm	
P ₃	14,5 mm	
d	3 mm	
K	M6	Conector de lubricación DIN3405-A
S ₁	6 mm	Tornillo de ajuste hexágono interior
S ₂	3 mm	Tornillo de contrafuerza hexágono interior
K	M6	Tamaño rosca k DIN
K M _A	17 Nm	Par de apriete de los tornillos de fijación
D ₂	6,6 mm	
A _{max}	10 mm	Carrera de tornillo A
Delta h _{max}	0,52 mm	Ajuste máximo
	0,05 mm	Revolución del tornillo de ajuste



Ver detalles del producto en Medias

11.11.2025, 17:41:29 UTC

SCHAEFFLER

Productos relacionados

UG9741, UGN9741-
A, UZ9741,
UZN9741-A,
U FK4710, UFB6412

Carriles-guía adecuados