

IMAGE
COMING SOON**KGHK06-B-PP-AS**

Unidad de rodamiento lineal de bolas

Linear ball bearing and housing unit; sealed, greased, with relubrication facility; corrosion-resistant design possible

Información técnica

Variante de su producto actual

Size code	06
Version	B
Seal	PP
Función de relubricación	AS

Medidas principales y datos de rendimiento

F _W	6 mm	Diameter of ball complement
H	27 mm	Height
L	22,2 mm	Longitud
B	32 mm	Anchura
C	340 N	Capacidad de carga dinámica
C ₀	240 N	Capacidad de carga estática
≈m	30 g	Peso

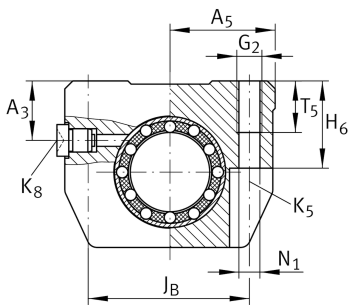
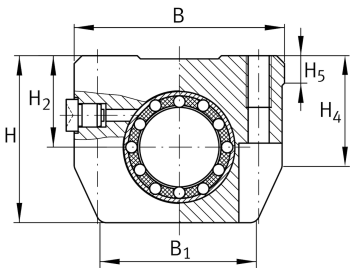

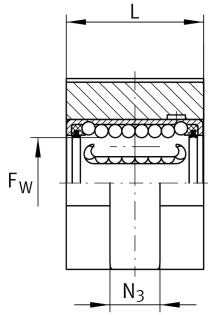

Medidas de montaje

J _B	23 mm	
Tol J _B	+ 0,15 mm	Upper tolerance
Tol J _B	- 0,15 mm	Lower tolerance
B ₁	25 mm	
A ₅	16 mm	
H ₂	13 mm	Center height
Tol H ₂	+ 0,01 mm	Upper tolerance
Tol H ₂	- 0,014 mm	Lower tolerance
H ₄	20,6 mm	Mounting Dimension
H ₅	5 mm	
T ₅	9 mm	
H ₆	13 mm	Mounting Dimension
A ₃	9 mm	
G ₂	M4	
N ₁	3,4 mm	
N ₃	7 mm	
K ₅	M3	
K ₈	NIPA1	Lubrication nipple