**LFSR32-100/360-ST** [↗](#)

Carril-guía

solid profile, curved guideway

Información técnica

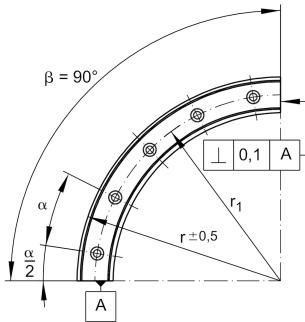
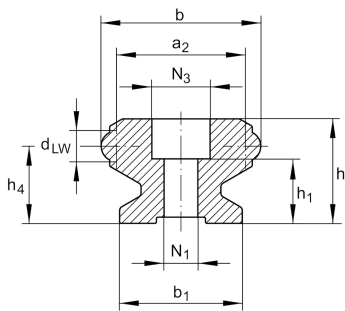

Variante de su producto actual

Size code	32
Radius	100
Angle	360°

Medidas principales y datos de rendimiento

h	20 mm	
b	32 mm	
r	100 mm	
≈m	1,82 kg	Peso

Medidas de montaje

a ₂	26 mm
b ₁	24 mm
d _{LW}	6 mm
h ₁	13,5 mm
h ₄	15 mm
N ₁	6,5 mm
N ₃	12 mm
r ₁	84 mm
X	12
α	30
a/2	15
β	360



LFSR../90-ST



LFSR../180-ST



LFSR../360-ST