



LS90120 [↗](#)

Disco de rodadura

Bearing washers, suitable for AXK and K811

Información técnica

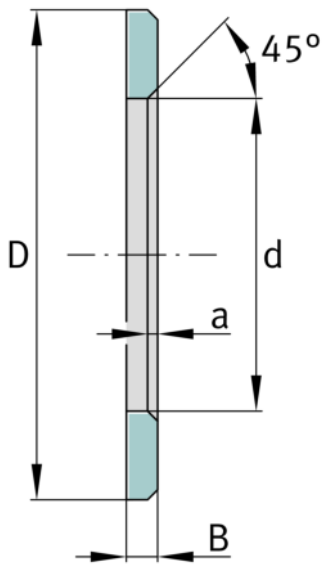

Medidas principales y datos de rendimiento

d	90 mm	Diámetro de agujero del anillo-guía
D	120 mm	Diámetro exterior del anillo-guía
B	6,5 mm	Anchura
	45 °	Ángulo del chaflán
a min	1,5 mm	Anchura del chaflán
≈m	0,234 kg	Peso

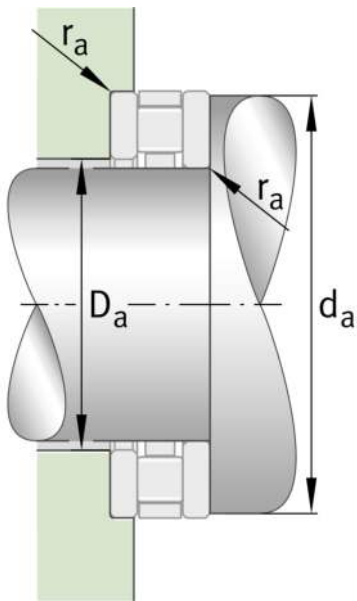



Ver detalles del producto en Medias

12.11.2025, 22:29:22 WET

SCHAEFFLER

