



### SD37X47X4 [↗](#)

Anillo obturador de ejes radial

Double lip sealing ring SD



## Información técnica

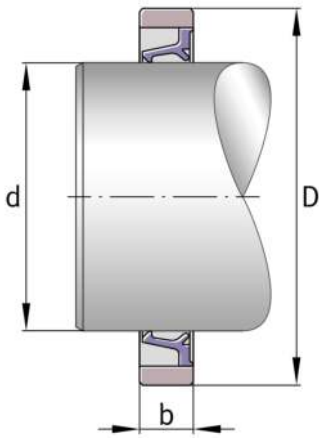

### Medidas principales y datos de rendimiento

D	47 mm	Diámetro exterior
≈m	2,53 g	Peso

### Medidas principales

B	4 mm	Width
---	------	-------