



SD19X27X4 [↗](#)

Anillo obturador de ejes radial

Double lip sealing ring SD



Información técnica

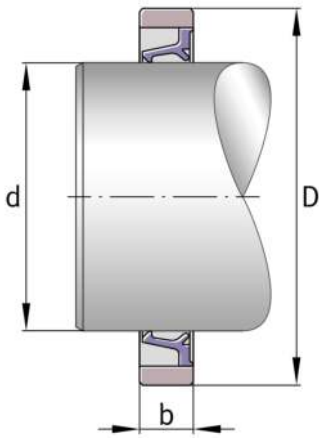

Medidas principales y datos de rendimiento

D	27 mm	Diámetro exterior
≈m	1,02 g	Peso

Medidas principales

B	4 mm	Width
---	------	-------