



### SD35X45X4 [↗](#)

Anillo obturador de ejes radial

Double lip sealing ring SD



#### Información técnica

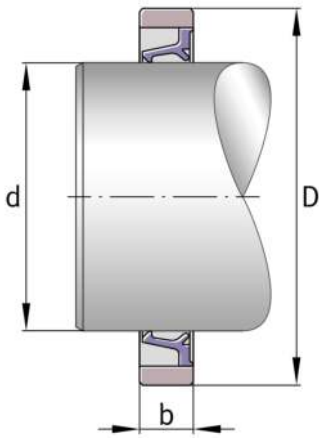

#### Medidas principales y datos de rendimiento

D	45 mm	Diámetro exterior
≈m	2,38 g	Peso

#### Medidas principales

B	4 mm	Width
---	------	-------