



### SD45X55X4 [↗](#)

Anillo obturador de ejes radial

Double lip sealing ring SD



## Información técnica

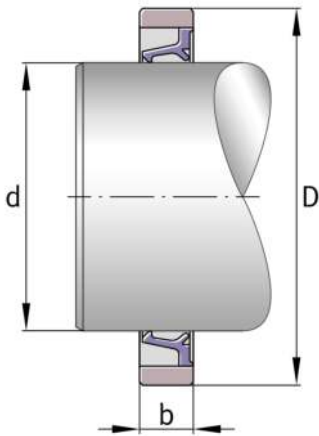

### Medidas principales y datos de rendimiento

D	55 mm	Diámetro exterior
≈m	3,03 g	Peso

### Medidas principales

B	4 mm	Width
---	------	-------