



SD50X62X5

Anillo obturador de ejes radial

Double lip sealing ring SD



Información técnica

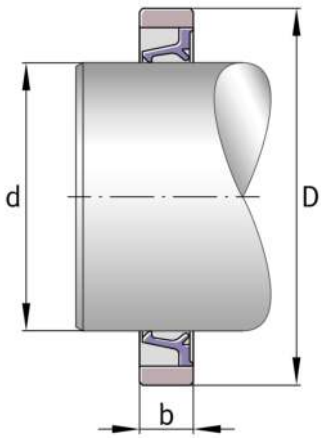

Medidas principales y datos de rendimiento

D	62 mm	Diámetro exterior
≈m	5,26 g	Peso

Medidas principales

B	5 mm	Width
---	------	-------