



SD28X35X4 [↗](#)

Anillo obturador de ejes radial

Double lip sealing ring SD



Información técnica

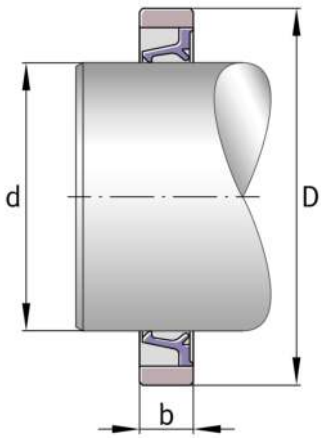

Medidas principales y datos de rendimiento

D	35 mm	Diámetro exterior
≈m	1,188 g	Peso

Medidas principales

B	4 mm	Width
---	------	-------