

**F-673270.06.TILL**

Rodamiento

Schaeffler Field Pro Disk Harrow Units

## Información técnica

**Medidas principales y datos de rendimiento**

d	32 mm	Bolt diameter
D	81,6 mm	Outer diameter housing
D <sub>1</sub>	117 mm	Diameter flange
B	102 mm	Total height unit
C <sub>r</sub>	50.000 N	Capacidad de carga dinámica, radial
C <sub>0r</sub>	40.000 N	Capacidad de carga estática, radial
m	2,59 kg	Peso

**Medidas de montaje**

J	98 mm	Diámetro del círculo primitivo de rodadura (agujeros)
d <sub>1</sub>	28 mm	Diameter adapter
d <sub>2</sub>	M12x1,25	Fixing bore metric
d <sub>3</sub>	25,5 mm	Length locking device
G	M22x1,5	Connection thread
l <sub>G</sub>	28,5 mm	Length thread
a <sub>3</sub>	12 mm	Width of adapter
n	6	Número de agujeros roscados

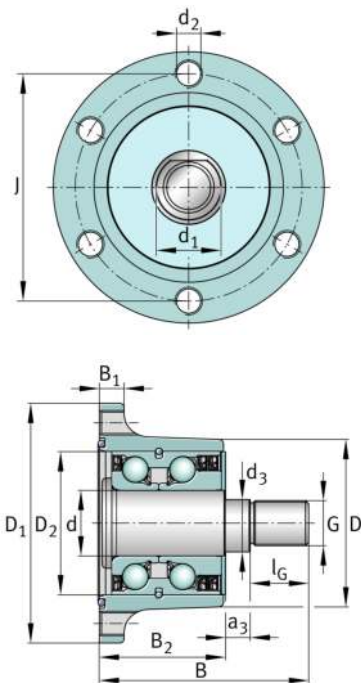



### Medidas

D <sub>2</sub>	70 mm	Outer diameter bearing
B <sub>1</sub>	12 mm	Thickness of flange
B <sub>2</sub>	61,5 mm	Height housing