



### SD18X24X3 [↗](#)

Anillo obturador de ejes radial

Double lip sealing ring SD



## Información técnica

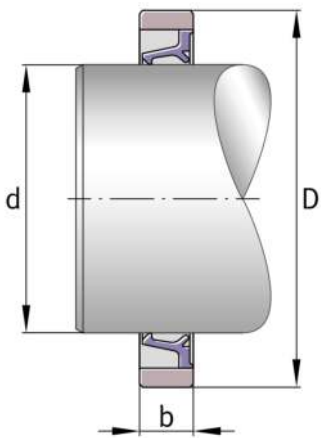

### Medidas principales y datos de rendimiento

D	24 mm	Diámetro exterior
≈m	0,555 g	Peso

### Medidas principales

B	3 mm	Width
---	------	-------