



SD17X23X3 [↗](#)

Anillo obturador de ejes radial

Double lip sealing ring SD



Información técnica

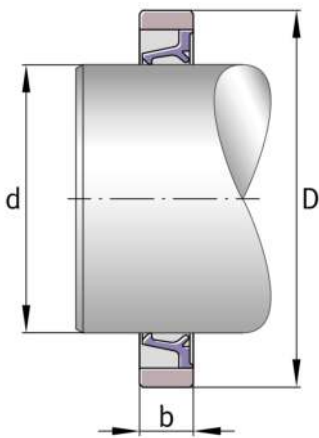

Medidas principales y datos de rendimiento

D	23 mm	Diámetro exterior
≈m	0,53 g	Peso

Medidas principales

B	3 mm	Width
---	------	-------