



IMAGE  
COMING SOON

**FAG**

**SPA3236-H-W-Y-BL-D** [↗](#)

Soporte tensor

## Información técnica



### Medidas principales y datos de rendimiento

d	160 mm	Shaft diameter
d <sub>c</sub>	176 mm	Chamfer diameter
h	450 mm	Height
a	600 mm	Length total

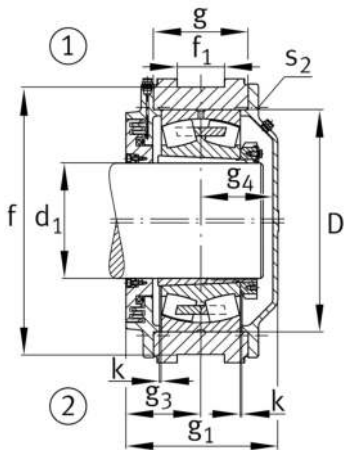
**Medidas**

a 1	420 mm	Length guidance groove
a 2	210 mm	Distance shaft axis
g 1	240 mm	Total width with lid
g 2	274 mm	Width total shaft
m	300 mm	Distance fork bore shaft center
r 1	90 mm	Fork radius
x	90 mm	Fork clearance
x 1	120 mm	Fork flange diameter
u	80 mm	Fork boring diameter
p	72 mm	Inner fork width
p 1	140 mm	Outer fork width
f	410 mm	Distance guidance grooves
f 1	93 mm	Width guidance groove
D	320 mm	Outside diameter bearing
k	3 mm	Axial displacement
g	138 mm	Anchura del cuerpo de soporte
g 3	127 mm	Locking collar width
g 4	105 mm	Distance bearing center cover
t	370 mm	Pitch circle diameter holes
s 2	M16	Agujero de fijación roscado
s 2	8	Number of screwing holes

**Información adicional**

23236..-K	Referencia rodamiento
H2336(-HG)	Manguito de fijación