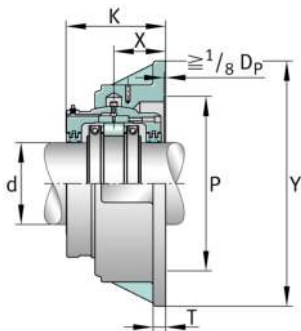

**FAG****S1BCF-412-FL**

Soporte de apoyo

Soporte-brid

Información técnica

**Medidas principales y datos de rendimiento**

d	≈ 120,65 mm	Shaft diameter
Y	≈ 431,8 mm	Flange outside diameter
K	≈ 176,212 mm	Width
≈m	74,843 kg	Peso

Medidas

	S1BCF-412-HD	Complete unit held
	S1BCF-412-FL	Complete unit float
	FH-8	Housing designation
X	≈ 98,425 mm	Bearing centerline location
Z	≈ 384,175 mm	Bolt circle diameter
S	≈ 271,462 mm	Bolt hole distance
T	≈ 25,4 mm	Thickness of flange
P	≈ 317,5 mm	Pilot counterbore diameter
S	4	# of Mounting Bolts
S	≈ 22,225 mm	Mounting bolt diameter