



IMAGE
COMING SOON

FAG

SPA3052-H-W-T-AL-D [↗](#)

Soporte tensor

Información técnica



Medidas principales y datos de rendimiento

d	240 mm	Shaft diameter
d _c	256 mm	Chamfer diameter
h	540 mm	Height
a	910 mm	Length total

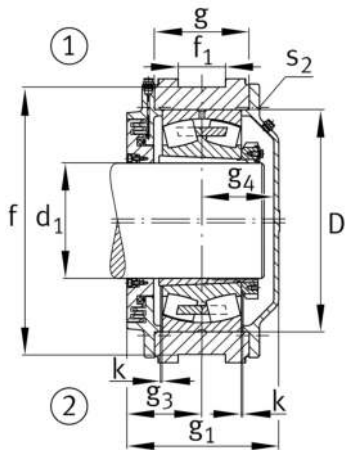
**Medidas**

a 1	500 mm	Length guidance groove
a 2	245 mm	Distance shaft axis
g 1	226 mm	Total width with lid
g 2	261 mm	Width total shaft
m	515 mm	Distance fork bore shaft center
r 1	150 mm	Fork radius
x	250 mm	Fork clearance
x 1	140 mm	Fork flange diameter
u	100 mm	Fork boring diameter
p	123 mm	Inner fork width
p 1	215 mm	Outer fork width
f	500 mm	Distance guidance grooves
f 1	65 mm	Width guidance groove
D	400 mm	Outside diameter bearing
k	4 mm	Axial displacement
g	130 mm	Anchura del cuerpo de soporte
g 3	113 mm	Locking collar width
g 4	103 mm	Distance bearing center cover
t	440 mm	Pitch circle diameter holes
s 2	M16	Agujero de fijación roscado
s 2	8	Number of screwing holes

Información adicional

23052..-K	Referencia rodamiento
H3052X(-HG)	Manguito de fijación