



IMAGE
COMING SOON

FAG

SPA3276-H-W-Y-BF-D [↗](#)

Soporte tensor

Información técnica



Medidas principales y datos de rendimiento

d	360 mm	Shaft diameter
d _c	384 mm	Chamfer diameter
h	820 mm	Height
a	1.385 mm	Length total

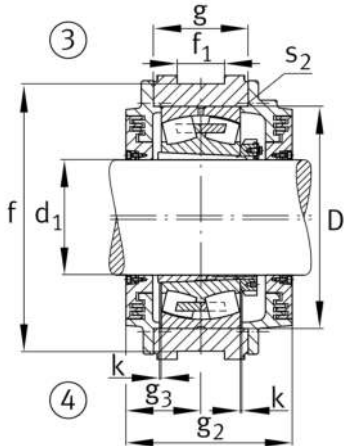
**Medidas**

a 1	810 mm	Length guidance groove
a 2	405 mm	Distance shaft axis
g 1	489 mm	Total width with lid
g 2	529 mm	Width total shaft
m	780 mm	Distance fork bore shaft center
r 1	200 mm	Fork radius
x	305 mm	Fork clearance
x 1	170 mm	Fork flange diameter
u	110 mm	Fork boring diameter
p	213 mm	Inner fork width
p 1	300 mm	Outer fork width
f	780 mm	Distance guidance grooves
f 1	123 mm	Width guidance groove
D	680 mm	Outside diameter bearing
k	5 mm	Axial displacement
g	295 mm	Anchura del cuerpo de soporte
g 3	232 mm	Locking collar width
g 4	244 mm	Distance bearing center cover
t	745 mm	Pitch circle diameter holes
s 2	M30	Agujero de fijación roscado
s 2	8	Number of screwing holes

Información adicional

23276..-K	Referencia rodamiento
H3276-HG	Manguito de fijación