



IMAGE
COMING SOON

FAG

SPA3044-H-W-T-AL-D [↗](#)

Soporte tensor

Información técnica



Medidas principales y datos de rendimiento

d	200 mm	Shaft diameter
d _c	216 mm	Chamfer diameter
h	480 mm	Height
a	615 mm	Length total

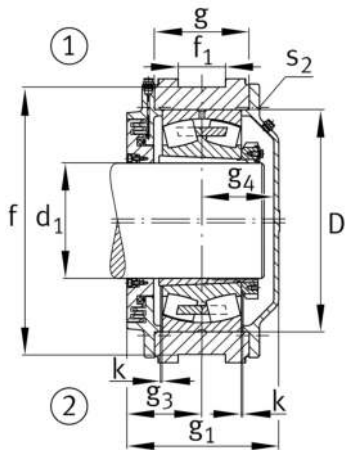
**Medidas**

a 1	430 mm	Length guidance groove
a 2	210 mm	Distance shaft axis
g 1	206 mm	Total width with lid
g 2	241 mm	Width total shaft
m	325 mm	Distance fork bore shaft center
r 1	80 mm	Fork radius
x	100 mm	Fork clearance
x 1	100 mm	Fork flange diameter
u	60 mm	Fork boring diameter
p	70 mm	Inner fork width
p 1	200 mm	Outer fork width
f	440 mm	Distance guidance grooves
f 1	65 mm	Width guidance groove
D	340 mm	Outside diameter bearing
k	3 mm	Axial displacement
g	115 mm	Anchura del cuerpo de soporte
g 3	103 mm	Locking collar width
g 4	95 mm	Distance bearing center cover
t	375 mm	Pitch circle diameter holes
s 2	M16	Agujero de fijación roscado
s 2	8	Number of screwing holes

Información adicional

23044..-K	Referencia rodamiento
H3044X(-HG)	Manguito de fijación