



IMAGE
COMING SOON

FAG

SPA3272-H-W-Y-BL-D [↗](#)

Soporte tensor

Información técnica



Medidas principales y datos de rendimiento

d	340 mm	Shaft diameter
d _c	364 mm	Chamfer diameter
h	830 mm	Height
a	1.390 mm	Length total

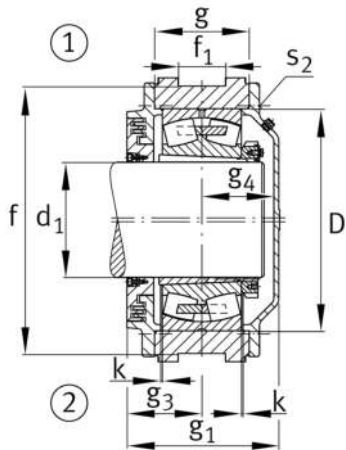
**Medidas**

a 1	800 mm	Length guidance groove
a 2	400 mm	Distance shaft axis
g 1	437 mm	Total width with lid
g 2	497 mm	Width total shaft
m	765 mm	Distance fork bore shaft center
r 1	225 mm	Fork radius
x	310 mm	Fork clearance
x 1	190 mm	Fork flange diameter
u	130 mm	Fork boring diameter
p	213 mm	Inner fork width
p 1	330 mm	Outer fork width
f	790 mm	Distance guidance grooves
f 1	123 mm	Width guidance groove
D	650 mm	Outside diameter bearing
k	5 mm	Axial displacement
g	267 mm	Anchura del cuerpo de soporte
g 3	216 mm	Locking collar width
g 4	209 mm	Distance bearing center cover
t	710 mm	Pitch circle diameter holes
s 2	M30	Agujero de fijación roscado
s 2	8	Number of screwing holes

Información adicional

23272..-K	Referencia rodamiento
H3272-HG	Manguito de fijación