



IMAGE
COMING SOON

FAG

SPA3248-H-W-T-AL-D

Soporte tensor

Información técnica



Medidas principales y datos de rendimiento

d	220 mm	Shaft diameter
d _c	236 mm	Chamfer diameter
h	580 mm	Height
a	970 mm	Length total

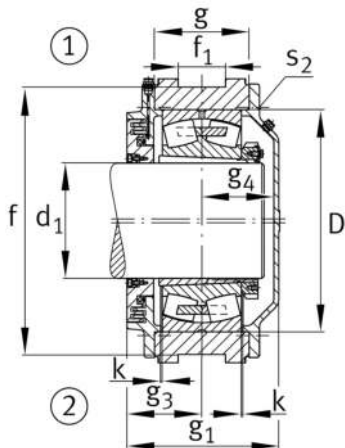
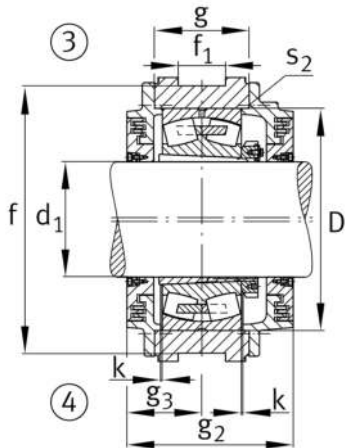
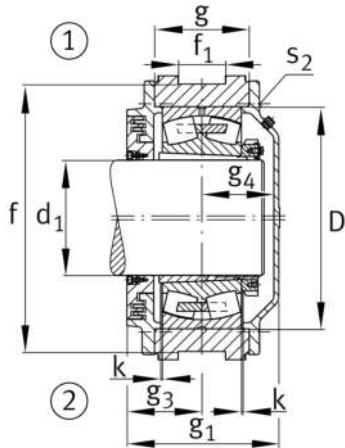
**Medidas**

a 1	560 mm	Length guidance groove
a 2	280 mm	Distance shaft axis
g 1	308 mm	Total width with lid
g 2	351 mm	Width total shaft
m	540 mm	Distance fork bore shaft center
r 1	150 mm	Fork radius
x	260 mm	Fork clearance
x 1	140 mm	Fork flange diameter
u	100 mm	Fork boring diameter
p	130 mm	Inner fork width
p 1	220 mm	Outer fork width
f	545 mm	Distance guidance grooves
f 1	95 mm	Width guidance groove
D	440 mm	Outside diameter bearing
k	4 mm	Axial displacement
g	190 mm	Anchura del cuerpo de soporte
g 3	158 mm	Locking collar width
g 4	140 mm	Distance bearing center cover
t	510 mm	Pitch circle diameter holes
s 2	M20	Agujero de fijación roscado
s 2	8	Number of screwing holes

Información adicional

23248..-K	Referencia rodamiento
H2348X(-HG)	Manguito de fijación