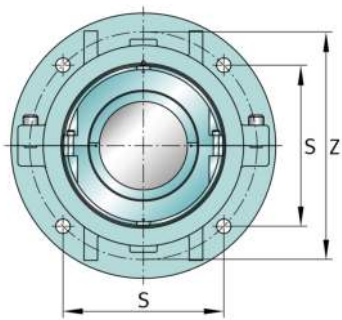

**FAG****S1BCF-1512-HD**

Soporte de apoyo

Soporte-brid

Información técnica

**Medidas principales y datos de rendimiento**

d	≈ 400,05 mm	Shaft diameter
Y	≈ 914,4 mm	Flange outside diameter
K	≈ 307,975 mm	Width
≈m	503,487 kg	Peso

Medidas

	S1BCF-1512-HD	Complete unit held
	S1BCF-1512-FL	Complete unit float
	FH-116	Housing designation
X	≈ 165,1 mm	Bearing centerline location
Z	≈ 800,1 mm	Bolt circle diameter
S	≈ 565,944 mm	Bolt hole distance
T	≈ 44,45 mm	Thickness of flange
P	≈ 673,1 mm	Pilot counterbore diameter
S	8	# of Mounting Bolts
S	≈ 31,75 mm	Mounting bolt diameter