

**FAG****S1BCF-515-HD**

Soporte de apoyo

Soporte-brid

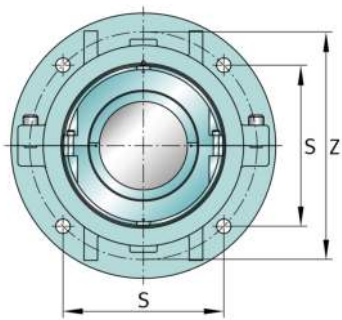

Información técnica

**Medidas principales y datos de rendimiento**

d	≈ 150,813 mm	Shaft diameter
Y	≈ 469,9 mm	Flange outside diameter
K	≈ 201,612 mm	Width
≈m	97,522 kg	Peso

Medidas

	S1BCF-515-HD	Complete unit held
	S1BCF-515-FL	Complete unit float
	FH-10	Housing designation
X	≈ 114,3 mm	Bearing centerline location
Z	≈ 412,75 mm	Bolt circle diameter
S	≈ 292,1 mm	Bolt hole distance
T	≈ 25,4 mm	Thickness of flange
P	≈ 346,075 mm	Pilot counterbore diameter
S	4	# of Mounting Bolts
S	≈ 25,4 mm	Mounting bolt diameter