



IMAGE  
COMING SOON

**FAG**

**SPA3240-H-W-Y-BF-D** [↗](#)

Soporte tensor

## Información técnica



### Medidas principales y datos de rendimiento

d	180 mm	Shaft diameter
d <sub>c</sub>	196 mm	Chamfer diameter
h	500 mm	Height
a	650 mm	Length total

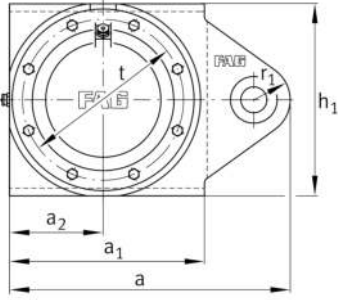
**Medidas**

a 1	470 mm	Length guidance groove
a 2	235 mm	Distance shaft axis
g 1	260 mm	Total width with lid
g 2	299 mm	Width total shaft
m	325 mm	Distance fork bore shaft center
r 1	90 mm	Fork radius
x	85 mm	Fork clearance
x 1	120 mm	Fork flange diameter
u	80 mm	Fork boring diameter
p	72 mm	Inner fork width
p 1	140 mm	Outer fork width
f	460 mm	Distance guidance grooves
f 1	103 mm	Width guidance groove
D	360 mm	Outside diameter bearing
k	4 mm	Axial displacement
g	158 mm	Anchura del cuerpo de soporte
g 3	138 mm	Locking collar width
g 4	114 mm	Distance bearing center cover
t	420 mm	Pitch circle diameter holes
s 2	M16	Agujero de fijación roscado
s 2	8	Number of screwing holes

**Información adicional**

23240..-K	Referencia rodamiento
H2340(-HG)	Manguito de fijación

