



IMAGE  
COMING SOON

**FAG**

**SPA3036-H-W-Y-BF-D** [↗](#)

Soporte tensor

## Información técnica



### Medidas principales y datos de rendimiento

d	160 mm	Shaft diameter
d <sub>c</sub>	176 mm	Chamfer diameter
h	370 mm	Height
a	540 mm	Length total

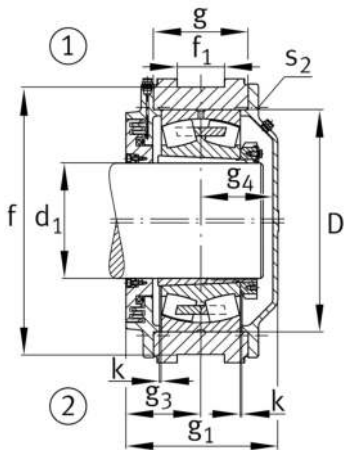
**Medidas**

a 1	375 mm	Length guidance groove
a 2	180 mm	Distance shaft axis
g 1	176 mm	Total width with lid
g 2	201 mm	Width total shaft
m	290 mm	Distance fork bore shaft center
r 1	70 mm	Fork radius
x	90 mm	Fork clearance
x 1	90 mm	Fork flange diameter
u	50 mm	Fork boring diameter
p	60 mm	Inner fork width
p 1	130 mm	Outer fork width
f	340 mm	Distance guidance grooves
f 1	60 mm	Width guidance groove
D	280 mm	Outside diameter bearing
k	3 mm	Axial displacement
g	100 mm	Anchura del cuerpo de soporte
g 3	88 mm	Locking collar width
g 4	80 mm	Distance bearing center cover
t	310 mm	Pitch circle diameter holes
s 2	M12	Agujero de fijación roscado
s 2	8	Number of screwing holes

**Información adicional**

23036..-K	Referencia rodamiento
H3036(-HG)	Manguito de fijación